



Kit Part Numbers

1-Reader, Dual-lane kit	HHR-4156B-GY (UPC: 816684003707), HHR-4156B-WH (UPC: 816684003714)
2-Reader, Dual-lane kit	HHR-4256B-GY (UPC: 816684003745), HHR-4256B-WH (UPC: 816684003752)
3-Reader, Dual-lane kit	HHR-4356B-GY (UPC: 816684003783), HHR-4356B-WH (UPC: 816684003790)

HHR-4000B_230524

Cypress Integration Solutions 40 Years of Access Control Ingenuity CypressIntegration.com

© 2023 Cypress Computer Systems 1778 Imlay City Road, Lapeer, MI 48446 800-807-2977



Specifications					
Kit Contents	HHR-4156B-GY	HHR-8056B-GY, HHR-8400, HHR-DOCK-GY, HHR-RCHL, HHR-BOOT			
	HHR-4156B-WH	HHR-8056B-WH, HHR-8400, HHR-DOCK-WH, HHR-RCHL, HHR-BOOT			
	HHR-4256B-GY	HHR-8056B-GY x2, HHR-8400, HHR-DOCK-GY x2, HHR-RCHL x2, HHR-BOOT x2			
	HHR-4256B-WH	HHR-8056B-WH x2, HHR-8400, HHR-DOCK-WH x2, HHR-RCHL x2, HHR-BOOT x2			
	HHR-4356B-GY	HHR-8056B-GY x3, HHR-8400, HHR-DOCK-GY x3, HHR-RCHL x3, HHR-BOOT x3			
	HHR-4356B-WH	HHR-8056B-WH x3, HHR-8400, HHR-DOCK-WH x3, HHR-RCHL x3, HHR-BOOT x2			
Individual Part Numbers	Reader - Dual-lane	HHR-8056B-GY (UPC: 816684002878), HHR-8056B-WH (UPC: 816684002885)			
	Base - Dual-lane	HHR-8400 (UPC: 816684002489)			
	Dock	HHR-DOCK-GY (UPC: 816684001291), HHR-DOCK-WH (UPC: 816684001307)			
	Charger	HHR-RCHL (UPC: 816684001284)			
	Boot with Shoulder Strap	HHR-BOOT (UPC: 816684002847)			
Physical	Handheld Reader	6.81" x 3.63" x 1.58" (17.30 x 9.22 x 4.01 cm) / 1.2 lbs (0.54 kg)			
	Charging Dock	4.76" x 4.1" x 2.2" (12.09 x 10.41 x 5.59 cm) / 0.35 lbs (0.16 kg)			
	Base Unit	9.25" x 7.0" x 2.25" (23.50 x 17.78 x 5.72 cm) / 1.3 lbs (0.59 kg)			
	Silicone Rubber Boot	8.00 L x 4.13 W x 1.85 H inches / 203.20 x 104.90 x 47.00 mm / Weight: 0.55 lbs. / 0.25 kg			
	Shoulder Strap	Approx. length: 31.5 - 57 inches (80 cm - 1.4m) / Weight: 0.19 lbs. / 90 g			
Environmental	Temperature Range	-17 to 54 C			
	HHR Reader	Weatherproof Enclosure - ASA+PC-FR - IP65			
	HHR Base Unit	Weatherproof Enclosure - Polycarbonate (PC) - IP65			
Electrical	Base Unit Supply Voltage	8-16Vdc Current 600mA			
	Internal LiPo Battery Pack	7.4V 3800mAh Rechargeable (not field-serviceable)			
	Charging Dock	Input: 100-240 Vac, 1A, 50/60Hz Max			
	Relays	<table border="1"> <tr> <td>Max Switching</td> <td>220Vdc 30W (resistive) 1A / 250Vac 37.5VA 1A</td> </tr> <tr> <td>Running Spec with load</td> <td>30Vdc 1A (resistive) / 125 Vac 0.3A (resistive), 1x10⁵ operations @ 20°C</td> </tr> </table>	Max Switching	220Vdc 30W (resistive) 1A / 250Vac 37.5VA 1A	Running Spec with load
Max Switching	220Vdc 30W (resistive) 1A / 250Vac 37.5VA 1A				
Running Spec with load	30Vdc 1A (resistive) / 125 Vac 0.3A (resistive), 1x10 ⁵ operations @ 20°C				
Credential Technologies	HID Prox, EM4102, AWID Prox; ISO14443A/B ISO15693, FeliCa™ (IDm); MIFARE Classic®, MIFARE DESFire® 0.6, MIFARE DESFire® EV1 (32 bit CSN), HID: iCLASS® Standard/SE/SR/Seos; PIV II, Secure Identity Object® (SIO®)				
Radio	Wireless Physical Layer	IEEE 802.15.4			
	Frequency	2.4 GHz ISM Band			
	Type	Direct Sequence Spread Spectrum (DSSS)			
	Transmit Power	15 dBm			
	Receiver Sensitivity	-103 dBm (1% PER, 250Kbps)			
	Modulation	O-QPSK			
	Agency Approvals	<table border="1"> <tr> <td>FCC Part 15.247: FCC ID: U90-SM220</td> </tr> <tr> <td>Industry Canada (IC): 7084A-SM220</td> </tr> <tr> <td>CE Certified: Certified to EN300 328 Version 1.8.1</td> </tr> </table>	FCC Part 15.247: FCC ID: U90-SM220	Industry Canada (IC): 7084A-SM220	CE Certified: Certified to EN300 328 Version 1.8.1
	FCC Part 15.247: FCC ID: U90-SM220				
Industry Canada (IC): 7084A-SM220					
CE Certified: Certified to EN300 328 Version 1.8.1					
Security Encryption	OSDP v2.2 with Secure Channel Encryption (IEC 60839-11-5)				
Wireless range	Indoor	150 feet* (45 meters*) typical range			
	Outdoor	500 feet* (150 meters*) typical range			
	<i>*Note: Distances are typical line-of-sight. Actual distance may vary depending upon terrain, RF environment, building materials, and height of antenna.</i>				
Additional Features	Vend button controls a relay for functions such as operating gates or possible duress notification.				
	Handheld Reader's gate-selection feature can be used for ingress and egress lanes or gates.				
	Breakaway strap and protective silicone rubber boot helps protect reader from drops, falls, and other physical damage.				

HHR-4X56B Dual-lane Kits - Table of Contents

Table of Contents	
Topic	Page
Specifications	2
Table of Contents	3
Product Overview	4
Wireless Encryption	5
Cable Recommendations and Battery Safety	6
What Is Included In The Kit	7
HHR-8400 Board A and Board B Pin Layout	8
HHR-8400 Wiring Diagram	9
LED Functions	10
Button Functions	11
Lane Functions	12
Reading Credentials	13
Access Granted / Access Denied Responses	14
Using the Vend Button	15-16
Bench Testing Setup	17
Bench Testing Steps	18
Field Installation	19-22
Battery Life, Charging, and Protective Boot	23-25
Troubleshooting	26-27
Installing External Pull-up Resistors	28

HHR-4X56B Dual-lane Kits - Overview

The Cypress Handheld Reader System with OSDP Secure Channel protocol: A wireless handheld credential reader which interfaces with the access controller through the reader's matched Base Unit, using an encrypted wireless link. The Handheld Reader is a portable proximity card reader that connects wirelessly to the access control panel. The Base Unit connects to the access control panel similar to a standard Wiegand reader and the access control panel validates the credentials. The Base Unit is able to provide an Access Granted or Access Denied response after a credential is presented. The Handheld Reader and Base Unit do not store any credential data. There are three types of Dual-lane kits: HHR-4156B (one reader), HHR-4256B (2 reader), and HHR-4356B (3 reader).

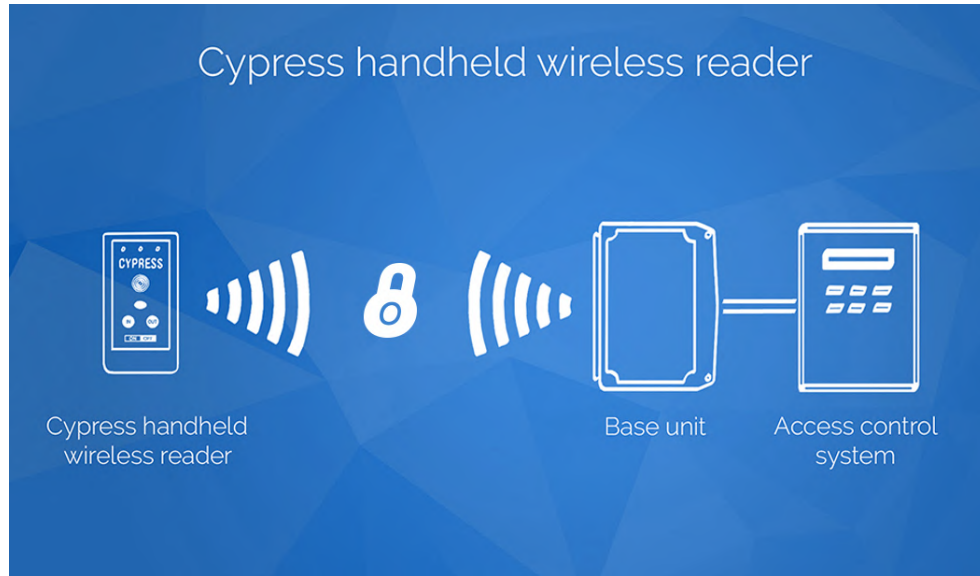

Advantages of OSDP Secure Channel Protocol

Application Protocol Integrity and Confidentiality Controls:

OSDP Secure Channel-compliant handheld units and base stations protect the integrity, confidentiality, and authenticity controls of all messages transmitted across the network.

Protocol Replay Protection:

Resilient against replay attacks, using a rolling Message Authentication Code to ensure no two messages appear the same as transmitted over the network, and no two identically received messages are accepted.

Handheld Reader Authentication State Linked to Authentication Attempt:

No message from the base station (or from an attacker) can cause the user interface to signal authorization without first having transmitted credential data to the base station.

Protocol Does Not Leak Sensitive Data:

The OSDP specification relies upon an inherently secure connection to perform initial key exchange, using a default key defined in the specification. This is done with randomly generated keys, at the the factory. The keys are not stored by Cypress.

Authentication Method Diminishes Efficacy of Brute-Force Attack:

The authentication method implements rate limiting, allowing one attempt per 5 seconds to diminish the efficacy of a brute-force attack while maintaining system responsiveness during normal use. The base station and handheld unit firmware do not accept repetitive badge presentations to prevent rogue hardware from searching badge space for authorized IDs.

Communication Security Does Not Rely on Protocol Secrecy:

Implementation of the Security Industry Association's Open Supervised Device Protocol (OSDP) eliminates the system's reliance on protocol secrecy. This protocol is well known and widely accepted in the access control industry as the solution to data security in physical access control.

HHR-4X56B Dual-lane Kits - Wireless Communication and Encryption

Wireless Communication

The wireless radios in the HHR-4000B readers and base units use the IEEE 802.15.4 standard for mesh networking. The HHR readers and base units form ad-hoc mesh networks, which do not require additional external infrastructure (such as WLAN) to function.

The communication protocol between HHR-4000B devices over the air is the Open Supervised Device Protocol (OSDP). OSDP is an IEC standard (IEC 60839-11-5). This protocol uses the AES-128 cipher in CBC mode for both data confidentiality and message authenticity.

Wireless Encryption

The HHR-4000B devices wireless communication utilize two layers of encryption. The first layer of encryption is on the radio link layer, which uses AES-128 to encrypt data packets between the radios in the Handheld readers and the Base Unit. The second layer of encryption is on the protocol level, which uses the OSDP Secure Channel protocol to encrypt the OSDP messages sent between the Base Unit and the Handheld Readers.

OSDP Secure Channel Encryption:

Each HHR-8056B reader has its own OSDP Secure Channel session with the HHR-8400 base. Each of these OSDP Secure Channel sessions is encrypted with its own encryption key.

Radio Level Encryption:

The radios in all of the HHR-8056B readers and the HHR-8400 base encrypt all of data being transmitted between the readers and the base. The radio level encryption uses AES128. The readers and the base share an encryption key for the radio level encryption.

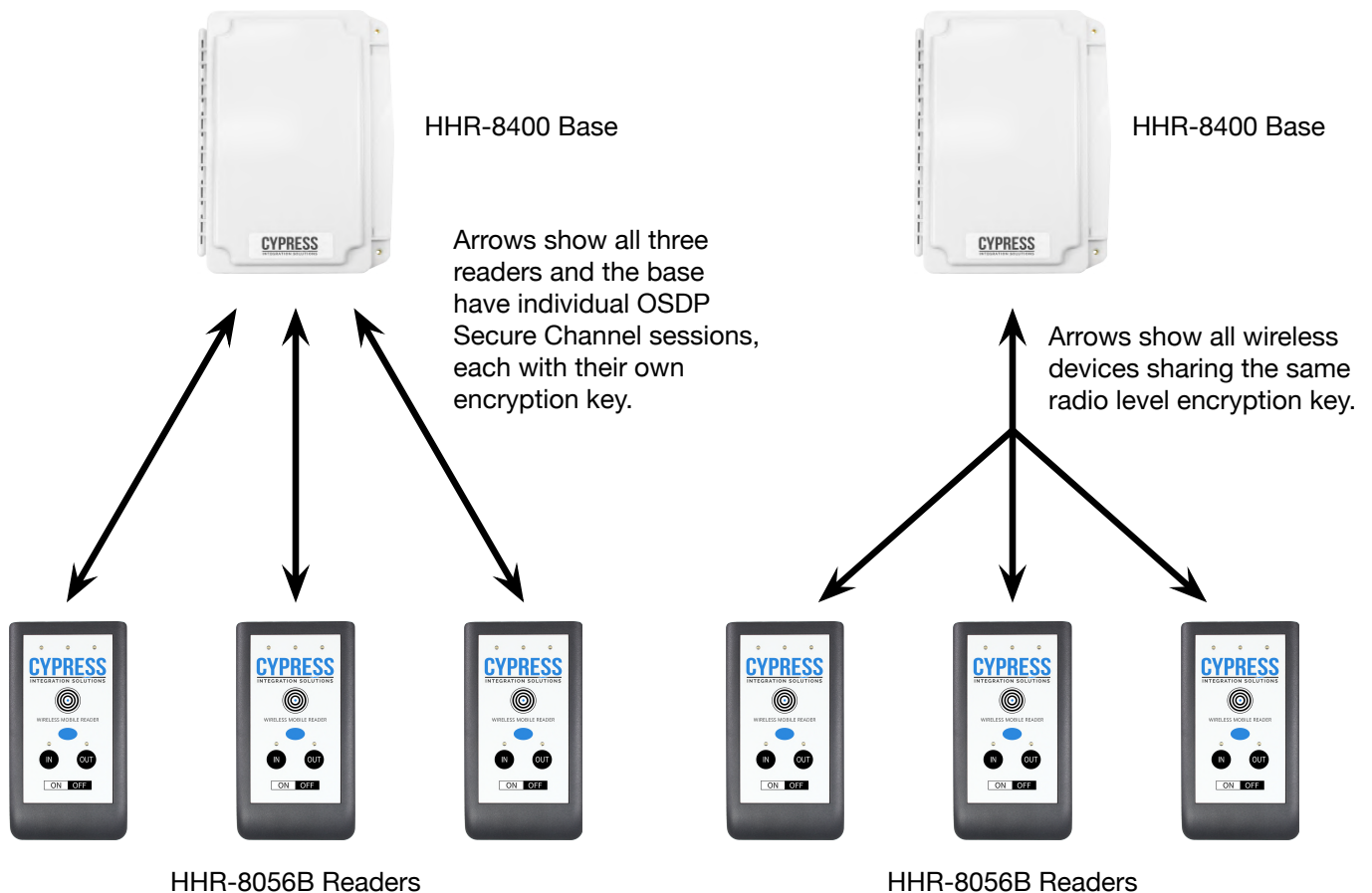

HHR-4X56B Dual-lane Kits - Cable Recommendations and Battery Safety

Unpacking

- Remove packaging from units and check interior of Base Unit for any shipping damage.
- Inventory any included parts (depending on model), shown below.
- Locate any terminal connectors, manuals / quick-starts, and warranty information.

Cable Recommendations	
Wiegand / LED	PVC - Belden 9942 or 8777 - 22 AWG 3 Pair Shielded, 250 feet max Plenum - Belden 82777 - 22 AWG 3 Pair Shielded, 250 feet max PVC - Belden 9873 - 20 AWG 3 Pair Shielded, 500 feet max Plenum - Belden 83606 or 85164 - 20 AWG 3 Pair Shielded, 500 feet max
Inputs / Outputs	PVC - Belden 8451 - 22 AWG 1 Pair, 1000 feet max Plenum - Belden 82761 - 22 AWG 1 Pair, 1000 feet max
Power	PVC - Belden 8461 - 18 AWG 1 Pair, 25 feet max Plenum - Belden 82740 - 18 AWG 1 Pair, 25 feet max

IMPORTANT SAFETY INSTRUCTIONS AND WARNINGS For LiPo BATTERIES

It is important to specifically use a Lithium Polymer/Li-ion charger only. Do not use a NiMH or NiCd charger. Failure to use the proper charger may cause a fire, which could result in personal injury/property damage. Never charge batteries unattended. When charging LiPo/Li-ion batteries, batteries should constantly be observed to monitor the charging process to ensure batteries are being charged properly and to respond to potential problems which may occur.

Some LiPo/Li-ion chargers on the market may have technical deficiencies and charge the LiPo/Li-ion batteries incorrectly or at an improper rate. It is your responsibility to ensure the charger you purchased works properly. If at any time a battery begins to heat, smoke, swell, or balloon, immediately stop charging the battery and disconnect the charger, then observe the battery in a safe place for approximately 15 minutes, since the battery could leak and react with air, causing chemicals to ignite and result in a fire. Since delayed chemical reaction can occur, it is best to observe the battery as a safety precaution, in a safe area outside of any building or vehicle and away from any combustible material.

HHR-4X56B Dual-lane Kits - What Is Included In The Kit

HHR-4156B

- HHR-8056B Dual-lane Reader x1 (*Reader can switch between In lane and OUT lane as necessary*)
- HHR-8400 Dual-lane Base x1
- HHR-DOCK Charging Dock x1
- HHR-RCHL Wall Plug Charger x1
- HHR-BOOT Protective boot for reader with removable, breakaway shoulder strap x1



HHR-4256B

- HHR-8056B Dual-lane Reader x2 (*Each reader can be set to IN or OUT Lane. Both readers can be used at the same time, as long as they are set to different lanes*)
- HHR-8400 Dual-lane Base x1
- HHR-DOCK Charging Dock x2
- HHR-RCHL Wall Plug Charger x2
- HHR-BOOT Protective boot for reader with removable, breakaway shoulder strap x2



HHR-4356B

- HHR-8056B Dual-lane Reader x3 (*Each reader can be set to IN or OUT lane. 2 readers can be used at the same time, as long as they are set to different lanes. The 3rd reader is a spare.*)
- HHR-8400 Dual-lane Base x1
- HHR-DOCK Charging Dock x3
- HHR-RCHL Wall Plug Charger x3
- HHR-BOOT Protective boot for reader with removable, breakaway shoulder strap x3



HHR-4X56B Dual-lane Kits - HHR-8400 Board A and Board B Pin Layout

Board A

1 8 - 16VDC		Relay 4 N.O. 1
2 Ground		Relay 4 COM 2
Status LED		Relay 4 N.C. 3
1 EXP(+)		Relay 3 N.O. 4
2 EXP(-)		Relay 3 COM 5
3 +5V Out		Relay 3 N.C. 6
4 P.R. 2		Ground 7
5 P.R. 1		Aux Out 8
6 LED In	Relay 2 In 9	Relay 1 In 10
7 D1/D Out		
8 D0/C Out		

Board B

1 8 - 16VDC		Relay 4 N.O. 1
2 Ground		Relay 4 COM 2
Status LED		Relay 4 N.C. 3
1 EXP(+)		Relay 3 N.O. 4
2 EXP(-)		Relay 3 COM 5
3 +5V Out		Relay 3 N.C. 6
4 P.R. 2		RS-232 TxD 7
5 P.R. 1		RS-232 RxD 8
6 LED In	Ground 9	Aux Out 10
7 D1/D Out	Relay 2 In 11	Relay 1 In 12
8 D0/C Out		

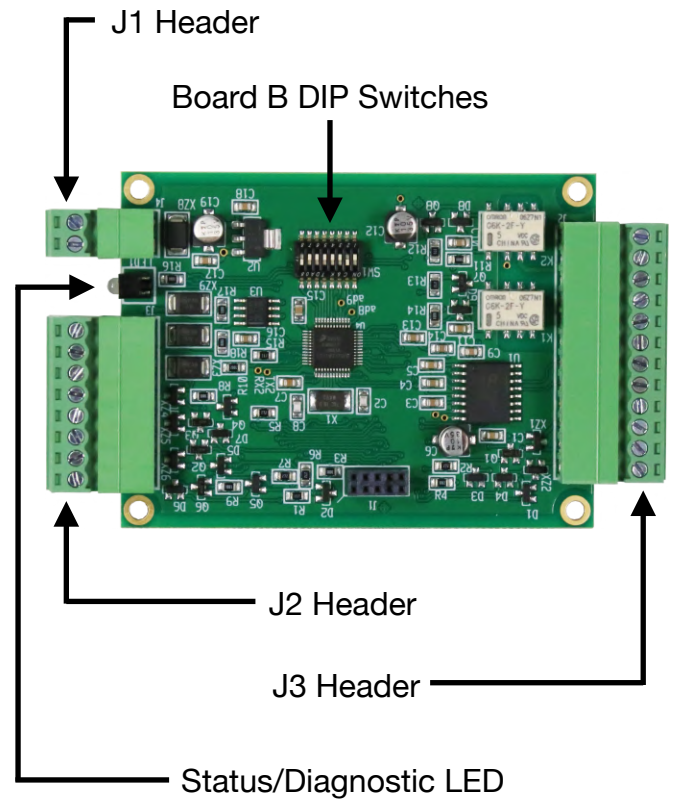
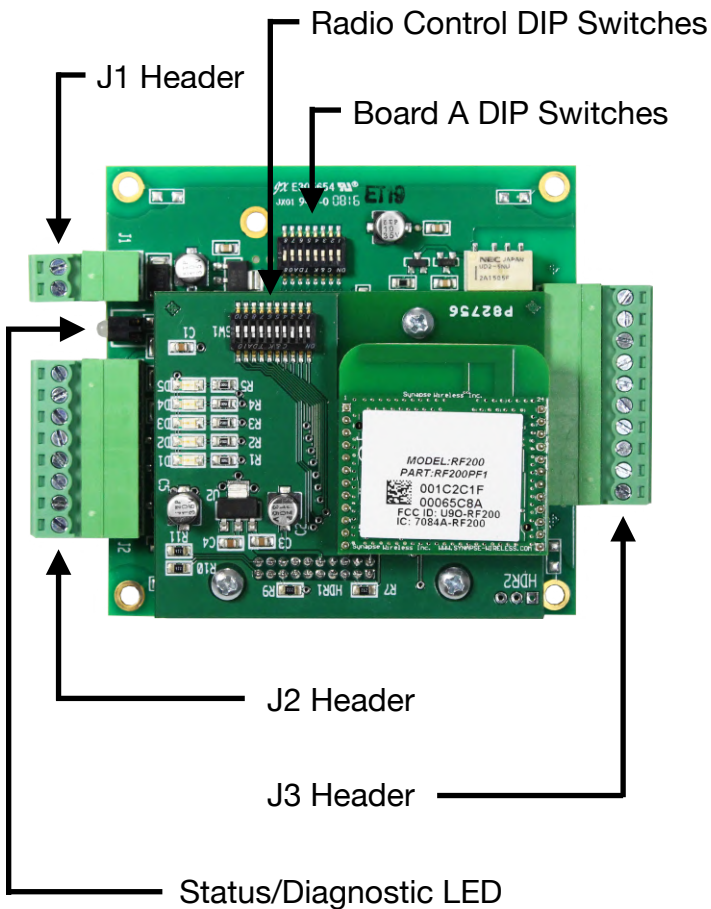

HHR-4X56B Dual-lane Kits - HHR-8400 Wiring Diagram

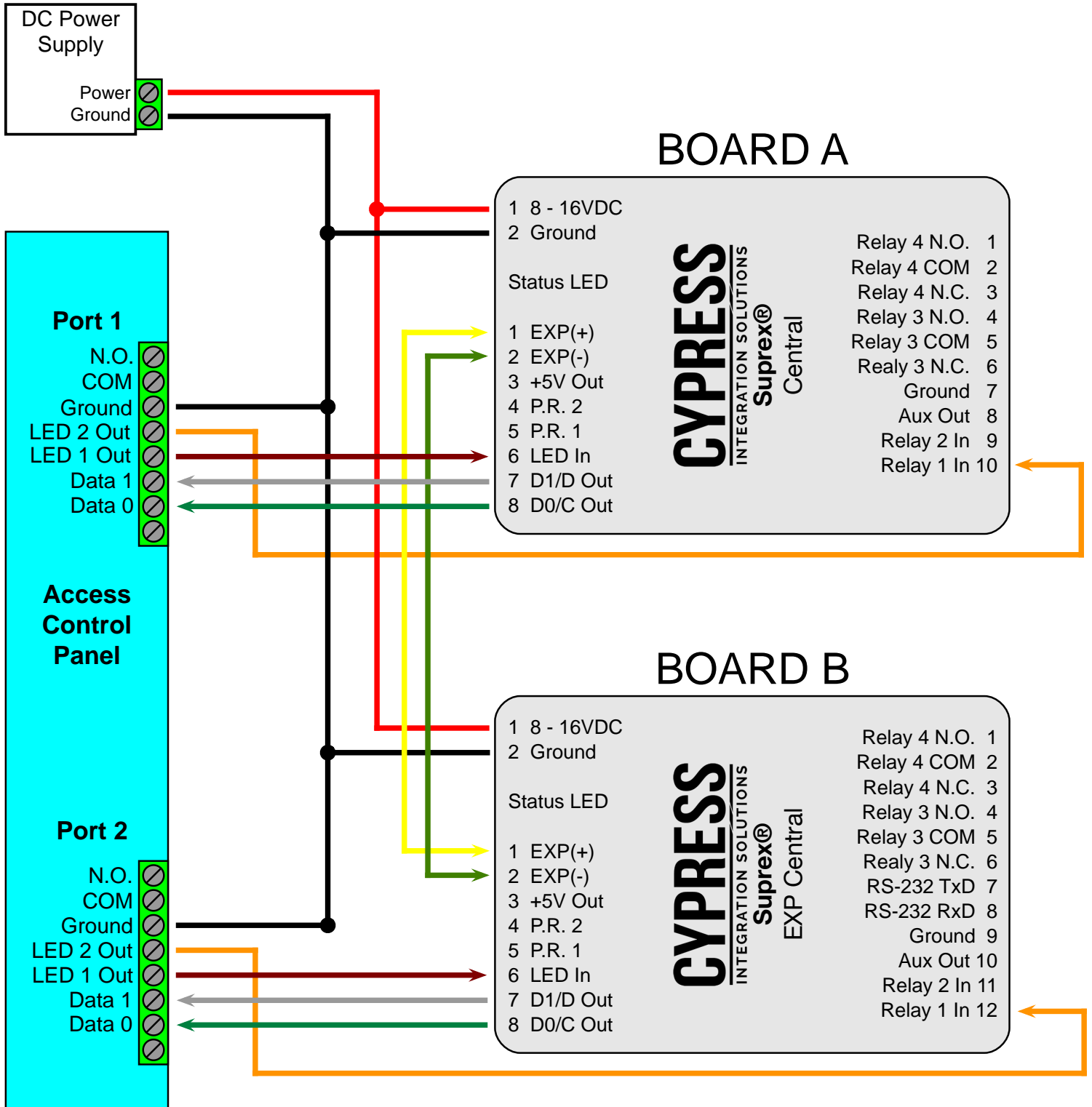

HHR-4X56B Dual-lane Kits - LED Functions

HHR-8056B-GY Dual-lane Reader

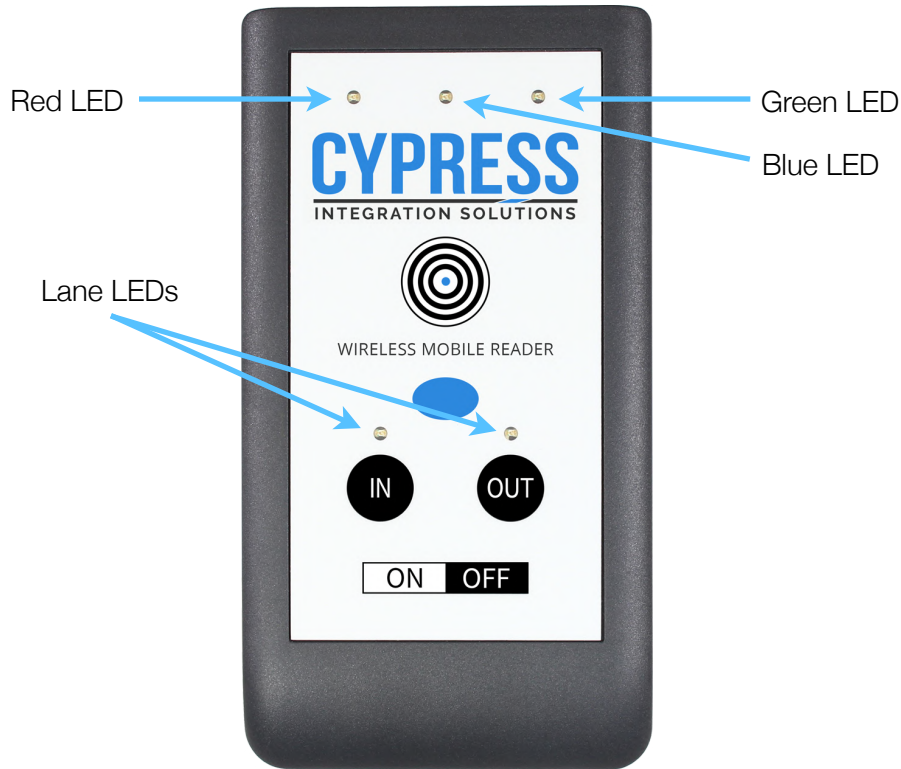

Handheld Reader LED Functions

- Red LED (top left - access denied)
 - Flashing red indicates access denied (negative acknowledge)
- Blue LED (top center - power & communication status)
 - Solid blue indicates that the HHR reader is powered on and is not communicating with the HHR base.
 - Flashing blue indicates that the HHR reader is communicating with the HHR base.
- Green LED (top right - access granted)
 - Flashing green indicates access granted (positive acknowledge).
- Red LED and Green LED (credential read indicator)
 - Red and Green LEDs flashing once indicates that a credential has been read by the HHR reader.
- Lane LEDs (above IN / OUT lane selection buttons - lane selection)
 - Solid red indicates the Handheld Reader is operating in this lane
 - Flashing red indicates a lane conflict error; multiple Handheld Readers are set to the same lane (see pg. 12)

Base Unit Diagnostic LED Functions

Board A and Board B each have a diagnostic LED. These diagnostic LEDs are located between the 2-pin and 8-pin headers on each board, see pg. 8.

The diagnostic LEDs are bi-color and may display red, green, or red and green, depending on the status.

- The Board A diagnostic LED will flash green when it is powered on. This is the only state for the Board A diagnostic LED.
- The Board B diagnostic LED will be solid red when it is powered on and not connected to Board A.
- The Board B diagnostic LED will be solid green when it is powered on and connected to Board A.

HHR-4X56B Dual-lane Kits - Button Functions

HHR-8056B-GY Dual-lane Reader

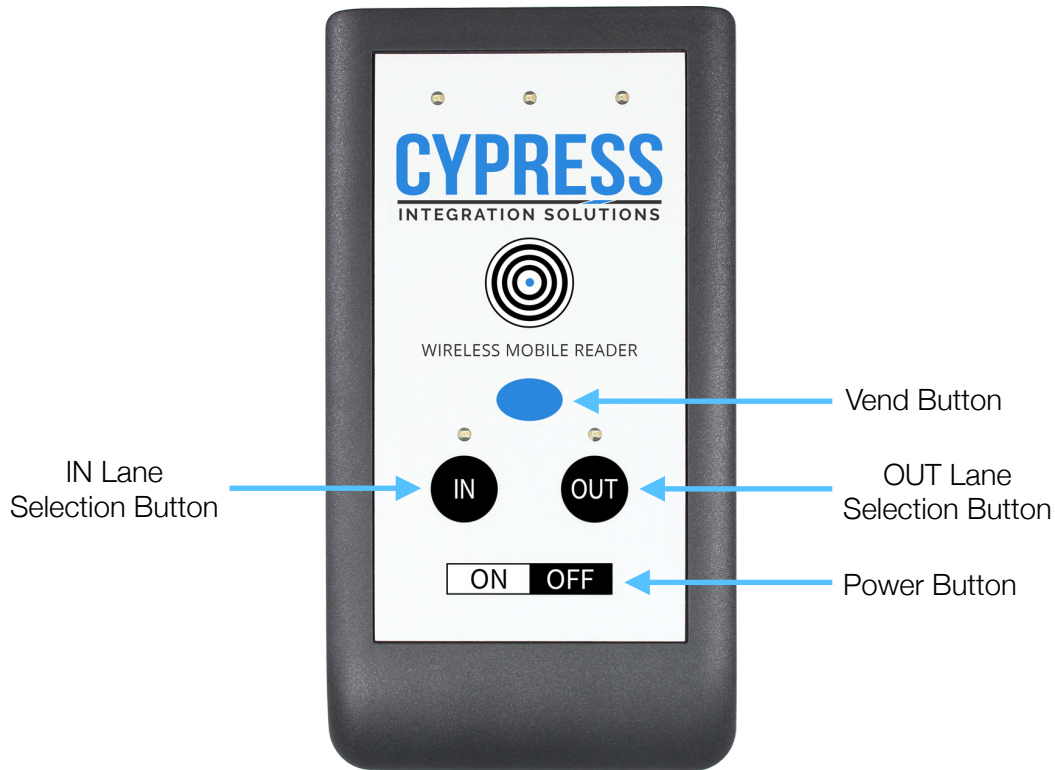

Handheld Reader Button Functions

- **Power Button:** When pressed, this button will power the handheld reader on or off. This button is a non-tactile button. The Red LED (top left) will be solid red when the Handheld Reader is powered on.
- **Vend Button:** Allows the user to operate a door, or a gate, or other equipment in the area. This needs to be configured by the installer. When pressed, Relay 3 on the Base Unit will be activated for as long as the button is held. When the Reader is set to the “In” Lane, the Vend Button controls Relay 3 on Board A. When the Reader is set to the “Out” Lane, the Vend Button controls Relay 3 on Board B.
- **IN Lane Selection Button:** When pressed, the Handheld Reader will be set to the IN Lane. The Lane LED above the IN Lane Selection Button will be solid red when the Handheld Reader is set to the IN Lane.
- **OUT Lane Selection Button:** When pressed, the Handheld Reader will be set to the OUT Lane. The Lane LED above the OUT Lane Selection Button will be solid red when the Handheld Reader is set to the OUT Lane.

HHR-4X56B Dual-lane Kits - Lane Functions

Using Lanes:

- The IN and OUT Lane Selection Buttons on the HHR-8056B readers are used to select the desired IN (ingress) or OUT (egress) door, gate, or lane.
- When lit, the LEDs above the Lane Selection Buttons indicate which lane the Handheld Reader is operating in. The Handheld Reader will always be in either the IN or OUT lane.
- The IN and OUT lanes have different Wiegand outputs on the Base Unit, this allows the Handheld Reader to appear as two separate readers to the access control panel. The IN Lane's Wiegand output is on Board A, and the OUT Lane's Wiegand output is on Board B.

Lane Conflicts:

- A Lane Conflict is caused by multiple Handheld Readers operating in the IN or OUT lane at the same time.
- When the Handheld Reader detects a Lane Conflict, the Lane LED above the IN or OUT Lane Selection Button (whichever Lane the conflict is in) will be flashing.
- During a Lane Conflict all affected Handheld Readers will still read credentials, however, no data will be sent to the Base Unit.
- Lane Conflicts can be resolved by ensuring that only one Handheld Reader is set to the IN or OUT Lane.



HHR-4X56B Dual-lane Kits - Reading Credentials

Reading Credentials

To read a credential, present it to the read area around the “bullseye” on the face of the reader.

Credential Read Area

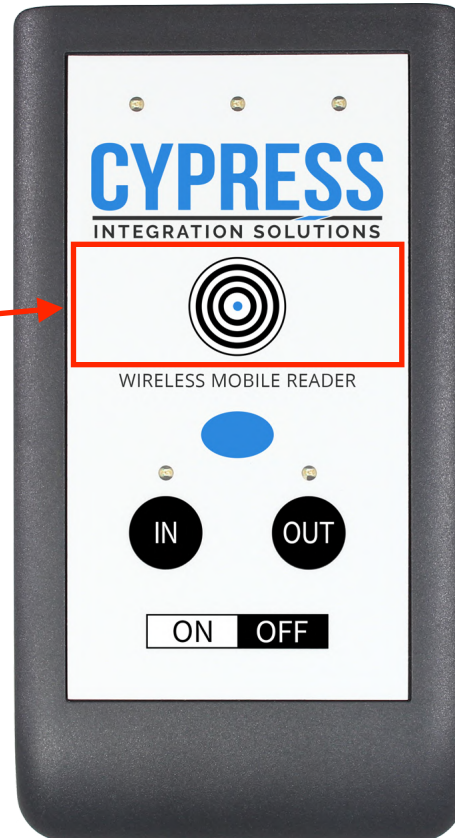

When the credential is read by the HHR-8056B the red and green LEDs will flash once and the reader will emit a medium pitch beep.

When the HHR-8056B reader is communicating with the Base Unit (indicated by the flashing blue LED) the credential data will be transmitted to the access controller from the Base Unit.

If the HHR-8056B reader is not communicating with the (indicated by the solid blue LED) no credential data will be transmitted to the access controller from the Base Unit.



HHR-4X56B Dual-lane Kits - Access Granted / Access Denied Responses

Access Granted Response

The Access Granted Response is controlled by the LED In pin on the Base Unit. When the LED In pin is an active low digital input. Its normal state is 5V and its active state is 0V. There is a 5 second window after a credential has been read by the reader that the Access Granted Response signal is acknowledged by the HHR reader. Otherwise, the state of the LED In pin will be ignored by the HHR reader.

After a credential has been read by the HHR reader and the LED In pin has been activated by the access controller; the green LED will flash, the reader will vibrate, and will emit a high pitched beep. The Access Granted Response will last for as long as the LED In is activated.

There are two LED In pins, one on Board A and one on Board B. The LED In pin on Board A controls the Access Granted Response while the HHR reader is set to IN Mode. The LED In pin on Board B controls the Access Granted Response while the HHR reader is set to OUT Mode.

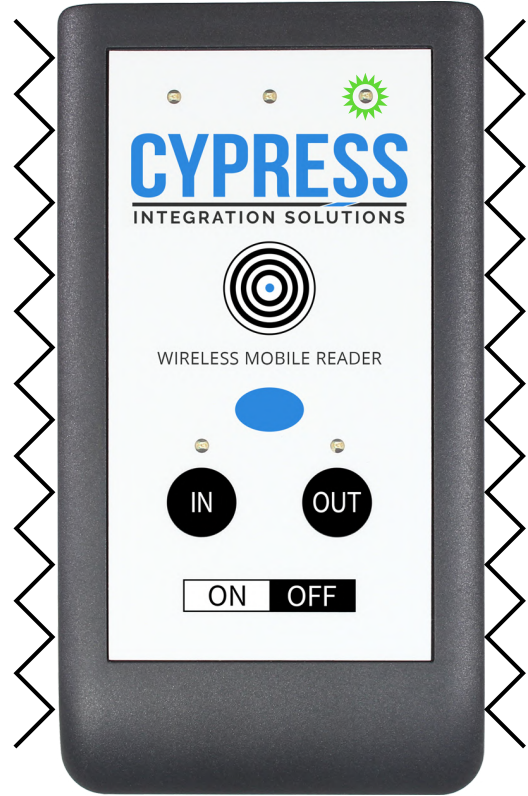

Access Denied Response

The Access Denied Response is controlled by the Relay 1 In pin on the Base Unit. When the Relay 1 In pin is an active low digital input. Its normal state is 5V and its active state is 0V. There is a 5 second window after a credential has been read by the reader that the Access Denied Response signal is acknowledged by the HHR reader. Otherwise, the state of the Relay 1 In pin will be ignored but the HHR reader.

After a credential has been read by the HHR reader and the Relay 1 In pin has been activated by the access controller; the red LED will flash, the reader will vibrate in a pulsing pattern, and emit a low pitched beep. The Access Denied Response will last for as long as the Relay 1 In pin is activated.

There are two Relay 1 In pins, one on Board A and one on Board B. The Relay 1 In pin on Board A controls the Access Denied Response while the HHR reader is set to IN Mode. The Relay 1 In pin on Board B controls the Access Denied Response while the HHR reader is set to OUT Mode.



HHR-4X56B Dual-lane Kits - Using the Vend Button

The Vend Button on the Reader is used to operate Relay 3 on Board A while the Reader is set to the IN Lane and Relay 3 on Board B while the Reader is set to the OUT Lane. Common applications for the Vend Button are allowing the Reader operator to manually open a gate or trigger a duress alarm.

Relay 3 on both Board A and Board B is a dry contact output by default. Power can be run through this relay if required, however, this relay rated for a max of 30 VDC at 1 amp. More detailed relay specifications can be found in the Specifications table on pg. 2.

Below are diagrams that show how Relay 3 changes state when the Vend button is pressed.

The diagram to the right shows the Reader set to the IN Lane. The Vend button is not being pressed and the state of Relay 3 on Board A is normal (continuity between Relay 3 Com and Relay 3 N.C.).

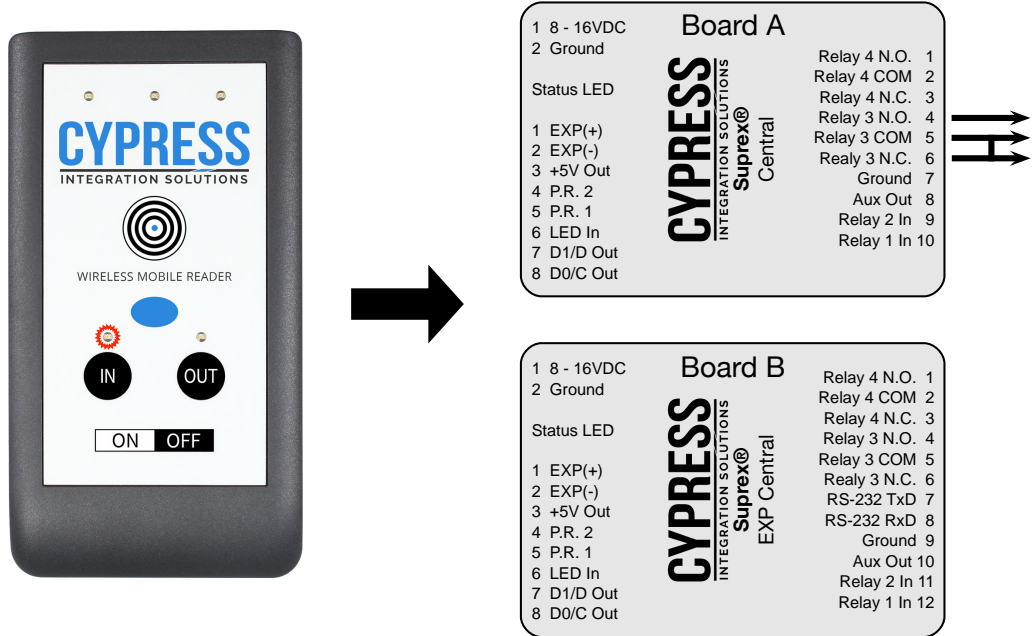

In this diagram, the Reader is set to the IN Lane and the Vend button is being pressed. The state of Relay 3 on Board A is active (continuity between Relay 3 Com and Relay 3 N.O.).

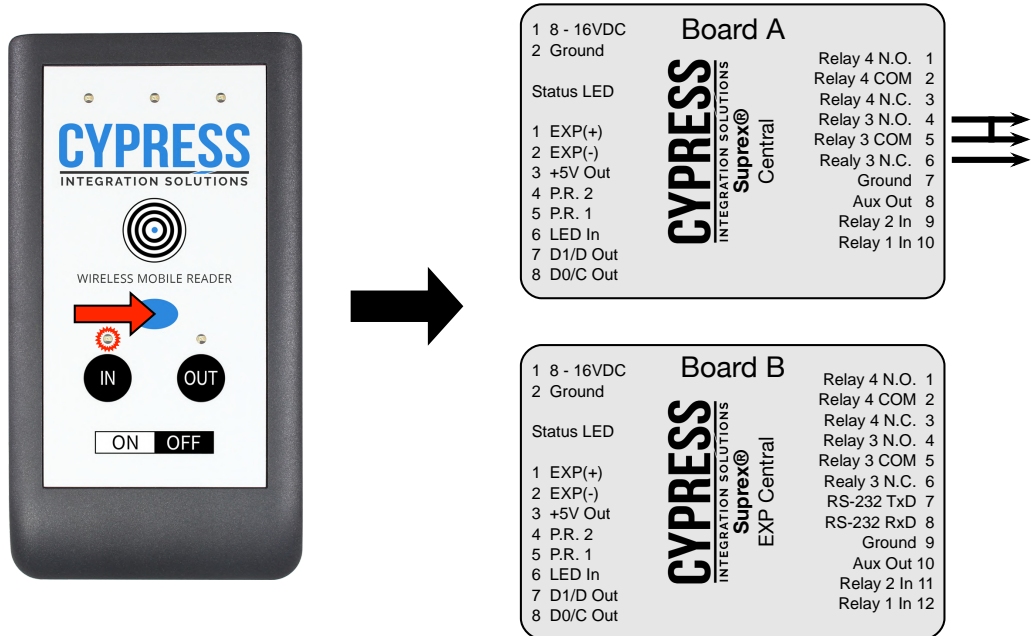

HHR-4X56B Dual-lane Kits - Using the Vend Button (continued)

The diagram to the right shows the Reader set to the OUT Lane. The Vend button is not being pressed and the state of Relay 3 on Board B is normal (continuity between Relay 3 Com and Relay 3 N.C.).



1 8 - 16VDC	CYPRESS INTEGRATION SOLUTIONS Suprex® Central	Relay 4 N.O. 1
2 Ground		Relay 4 COM 2
Status LED		Relay 4 N.C. 3
1 EXP(+)		Relay 3 N.O. 4
2 EXP(-)		Relay 3 COM 5
3 +5V Out		Relay 3 N.C. 6
4 P.R. 2		Ground 7
5 P.R. 1		Aux Out 8
6 LED In		Relay 2 In 9
7 D1/D Out		Relay 1 In 10
8 D0/C Out		

1 8 - 16VDC	CYPRESS INTEGRATION SOLUTIONS Suprex® EXP Central	Relay 4 N.O. 1
2 Ground		Relay 4 COM 2
Status LED		Relay 4 N.C. 3
1 EXP(+)		Relay 3 N.O. 4
2 EXP(-)		Relay 3 COM 5
3 +5V Out		Relay 3 N.C. 6
4 P.R. 2		RS-232 Tx D 7
5 P.R. 1		RS-232 Rx D 8
6 LED In		Ground 9
7 D1/D Out		Aux Out 10
8 D0/C Out		Relay 2 In 11
		Relay 1 In 12



In this diagram, the Reader is set to the OUT Lane and the Vend button is being pressed. The state of Relay 3 on Board B is active (continuity between Relay 3 Com and Relay 3 N.O.).

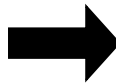

1 8 - 16VDC	CYPRESS INTEGRATION SOLUTIONS Suprex® Central	Relay 4 N.O. 1
2 Ground		Relay 4 COM 2
Status LED		Relay 4 N.C. 3
1 EXP(+)		Relay 3 N.O. 4
2 EXP(-)		Relay 3 COM 5
3 +5V Out		Relay 3 N.C. 6
4 P.R. 2		Ground 7
5 P.R. 1		Aux Out 8
6 LED In		Relay 2 In 9
7 D1/D Out		Relay 1 In 10
8 D0/C Out		

1 8 - 16VDC	CYPRESS INTEGRATION SOLUTIONS Suprex® EXP Central	Relay 4 N.O. 1
2 Ground		Relay 4 COM 2
Status LED		Relay 4 N.C. 3
1 EXP(+)		Relay 3 N.O. 4
2 EXP(-)		Relay 3 COM 5
3 +5V Out		Relay 3 N.C. 6
4 P.R. 2		RS-232 Tx D 7
5 P.R. 1		RS-232 Rx D 8
6 LED In		Ground 9
7 D1/D Out		Aux Out 10
8 D0/C Out		Relay 2 In 11
		Relay 1 In 12



HHR-4X56B Dual-lane Kits - Bench Testing Setup

Bench Test Setup

1. Before installing the Base Unit and Handheld Reader in the field, they should be tested at a convenient bench top location. This will make it easier to troubleshoot potential issues.
2. The Base Unit and Handheld Reader should be at least 24 inches apart during bench testing.
3. Connect the Base Unit to the access controller and follow the steps below.
4. To connect the Base Unit to the access controller, 2 separate Wiegand ports must be available.
5. Connecting Board A to the access controller:
 - A. Wiegand Data: Connect Data 0, Data 1, and a common ground to the one Wiegand port on the access controller.
 - B. Access Granted Response: Connect an active low digital output to the LED In pin. Alternatively, a dry contact can be connected to the LED In pin and Ground. Make sure the output connected to the LED In pin is configured to activate for at least one second when a valid credential is received on this Wiegand port.
 - C. Access Denied Response: Connect an active low digital output to the Relay 1 In pin. Alternatively, a dry contact can be connected to the Relay 1 In pin and Ground. Make sure the output connected to the Relay 1 In pin is configured to activate for at least one second when an invalid credential is received on this Wiegand port.
 - D. Vend Feature: Connect Relay 3 COM and Relay 3 N.O. (normally open) to the access controller. This relay output can be used to control a door, a gate, or other equipment.
6. Connecting Board B to the access controller:
 - A. Wiegand Data: connect Data 0, Data 1, and a common ground to another Wiegand port on the access controller.
 - B. Access Granted Response: connect an active low digital output to the LED In pin. Alternatively, a dry contact can be connected to the LED In pin and Ground. Make sure the output connected to the LED In pin is configured to activate for at least one second when a valid credential is received on this Wiegand port.
 - C. Access Denied Response: Connect an active low digital output to the Relay 1 In pin. Alternatively, a dry contact can be connected to the Relay 1 In pin and Ground. Make sure the output connected to the Relay 1 In pin is configured to activate for at least one second when an invalid credential is received on this Wiegand port.
 - D. Vend Feature: connect Relay 3 COM and Relay 3 N.O. (normally open) to the access controller. This relay output can be used to control a door, a gate, or other equipment.
7. Board A and Board B need to be connected. Connect EXP(+) on Board A to EXP(+) on Board B. Connect EXP(-) on Board A to EXP(-) to Board B.
8. Use a power supply that can supply 8-16Vdc @ 600mA. Both Board A and Board B need to have a power connection, and each require 300 mA.

HHR-4X56B Dual-lane Kits - Bench Testing Steps

Bench Testing Steps

The HHR-4256B and HHR-4356B kits have multiple readers, go through steps 1-8 for each reader.

1. Power on the reader. Press the IN lane selection button to set the reader to the IN lane. The blue LED will be on and solid when the reader is powered on. The blue LED will change to flashing when the reader is communicating with the Base Unit.
2. Present a valid credential to the reader. The red and green LEDs will flash once, indicating the credential has been read. Verify that the access controller has received the read on the Wiegand port Board A is connected to. Observe the Access Granted Response; the green LED will be flashing, the reader will vibrate, and the reader will emit a high pitched tone. The Access Granted Response will last as long as the LED In pin on Board A is activated.
3. Present an invalid credential to the reader. The red and green LEDs will flash once, indicating the credential has been read. Verify that the access controller has received the read on the Wiegand port Board A is connected to. Observe the Access Denied Response; the red LED will be flashing, the reader will vibrate in a pulsing pattern, and the reader will emit a low pitched tone. The Access Denied Response will last as long as the Relay 1 In pin on Board A is activated.
4. Press and release the Vend button. Verify that Relay 3 on Board A has changed state. Observe that the duress alarm activates, the door/gate opens, etc. A volt meter in continuity mode can also be used to determine the state of the relay. When the Vend Button is pressed, there will be continuity between Relay 3 COM and Relay 3 N.O. for as long as the Vend Button is held down.
5. Press the OUT lane selection button to set the reader to the OUT lane. The blue LED should still be flashing, indicating the reader is communicating with the Base Unit.
6. Present a valid credential to the reader. The red and green LEDs will flash once, indicating the credential has been read. Verify that the access controller has received the read on the Wiegand port Board B is connected to. Observe the Access Granted Response; the green LED will be flashing, the reader will vibrate, and the reader will emit a high pitched tone. The Access Granted Response will last as long as the LED In pin on Board B is activated.
7. Present an invalid credential to the reader. The red and green LEDs will flash once, indicating the credential has been read. Verify that the access controller has received the read on the Wiegand port Board B is connected to. Observe the Access Denied Response; the red LED will be flashing, the reader will vibrate in a pulsing pattern, and the reader will emit a low pitched tone. The Access Denied Response will last as long as the Relay 1 In pin on Board B is activated.
8. Press and release the Vend button. Verify that Relay 3 on the Board B has changed state. Observe that the duress alarm activates, the door, gate, or other equipment. A volt meter in continuity mode can also be used to determine the state of the relay. When the Vend Button is pressed, there will be continuity between Relay 3 COM and Relay 3 N.O. for as long as the Vend Button is held down.
9. Once the HHR Base Unit and Reader(s) have passed these bench testing steps, the components are ready to be installed in the field.

HHR-4X56B Dual-lane Kits - Field Installation

A. Determine Base Unit Location

1. The Base Unit should be mounted in a location which allows for the maximum range between the Base Unit and the Handheld Reader. *Typical maximum range for the wireless connection between the Handheld Reader and the Base Unit is 150 ft. (45 m) line-of-sight indoors, or 500 ft. (152 m) line-of-sight outdoors.*
2. It is not recommended to locate the Base Unit directly above the area where the Handheld Readers will be used, as this may cause communication problems.
3. The Base Unit location must accommodate a wired connection to the access controller (see Section C).

B. Mounting the Base Unit

1. It is recommended to temporarily set up the Base Unit at its desired mounting location to test communication with the Handheld Reader before permanently mounting the Base Unit. Use a battery to power the Base Unit and test the wireless connection between Base Unit and the Handheld Reader in the desired operating area.
2. The Base Unit should be mounted at least 10 feet (3 m) above the ground outdoors, or 6-8 feet (1.8 - 2.4 m) above the floor indoors. If obstacles are present (such as vehicles, trains, building, trees, etc.) choose a location high enough, or with good line-of-sight to avoid interference from these obstacles.
3. A non-metal mounting surface is recommended for the Base Unit, as metal surfaces reduce the effective range between the Base Unit and the Handheld Reader. If mounting the Base Unit on a metal surface is unavoidable, use a non-metal spacer to space the Base Unit at least 2 inches (5 cm) from the metal surface.
4. The Base Unit must be mounted in the upright position. When correctly oriented, the “Cypress” sticker can be clearly read and the enclosure door will open to the left.
5. Remove the plastic backplate and circuit boards from the enclosure before drilling any holes in the enclosure to avoid damaging the backplate or circuit boards. The backplate is held in place by 4 Phillips screws at each corner of the enclosure.

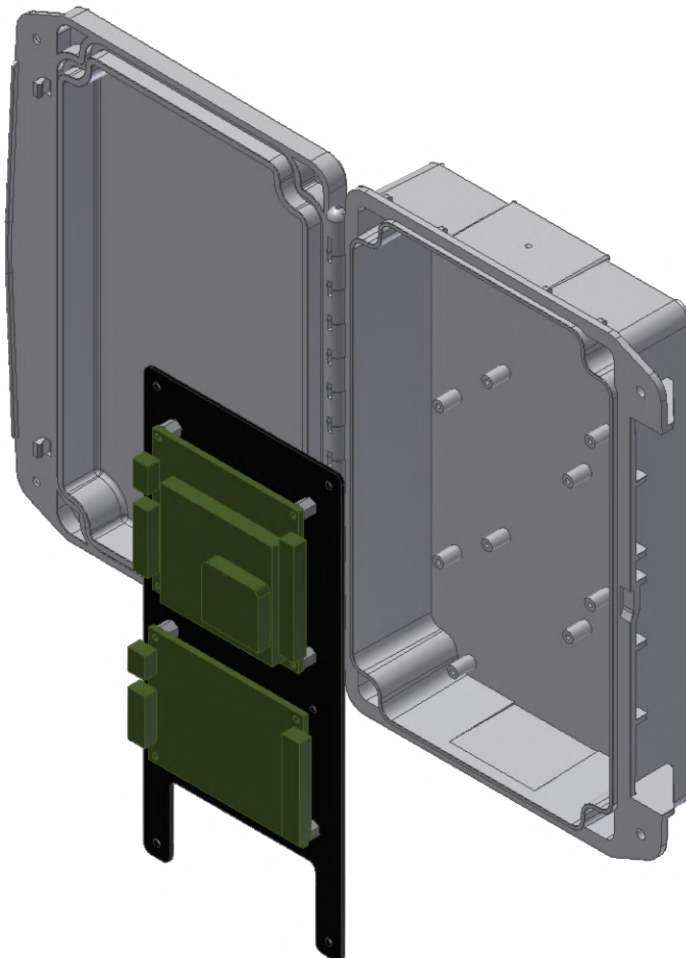

Tools Needed

Drill

Phillips Screwdriver

3/16" Drill Bit (if using wall anchors)

7/64" Drill Bit (if not using wall anchors)

HHR-4X56B Dual-lane Kits - Field Installation (cont.)

6. Install a grommet on the bottom of the enclosure using the preformed divot as a guide for the drill bit (see diagram, below).

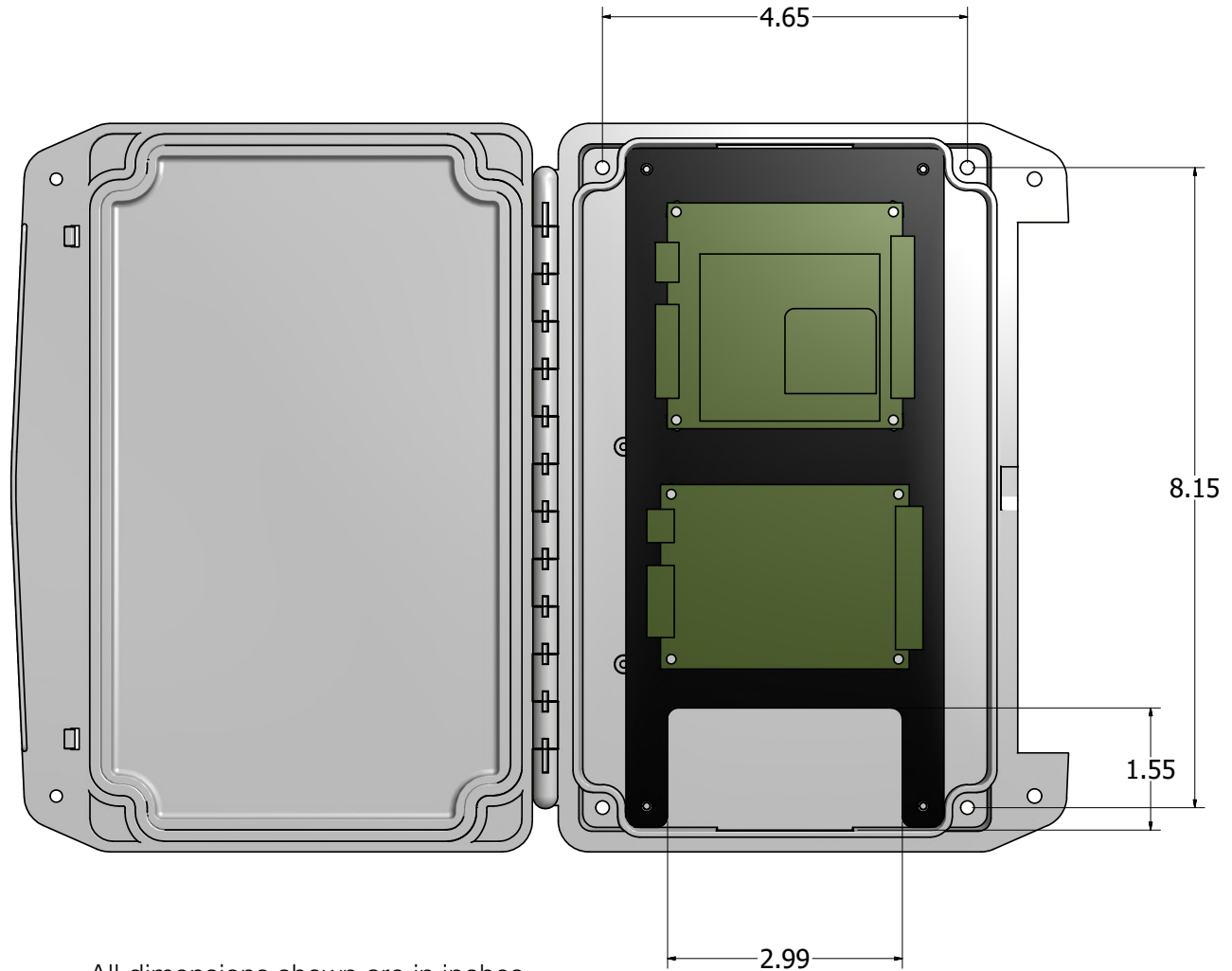

All dimensions shown are in inches.

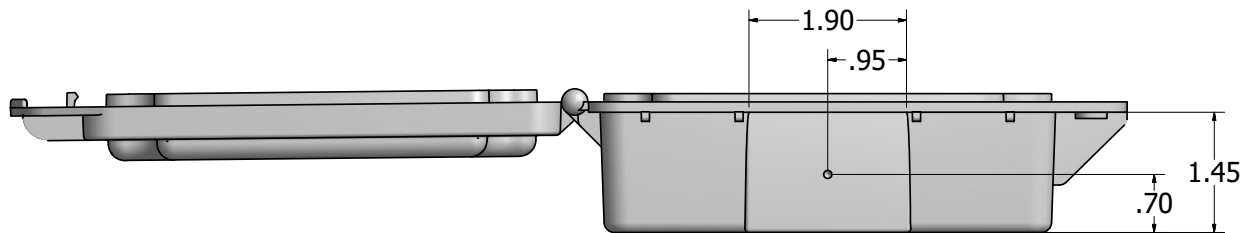

7. Drill the mounting holes into the mounting surface.
- If using wall anchors: following the hole pattern in the diagram above, use an appropriate 3/16-inch drill bit to drill holes into the surface with a depth of at least 1.25 inches. Place the wall anchors into the newly drilled holes.
 - If not using wall anchors: following the hole pattern in the diagram above, use an appropriate 7/64-inch drill bit to drill holes into the surface with a depth of at least 1.25 inches.
8. Use a Phillips screwdriver to mount the enclosure to the surface using the four #8 x 1 inch screws included with the enclosure (see diagram, pg. 21).
9. Use a Phillips screwdriver to mount the backplate and circuit boards in the enclosure.
10. Enclosure locking screws (6-32 x 3/8) max torque rating 8.5 inch-pounds.

HHR-4X56B Dual-lane Kits - Field Installation (cont.)

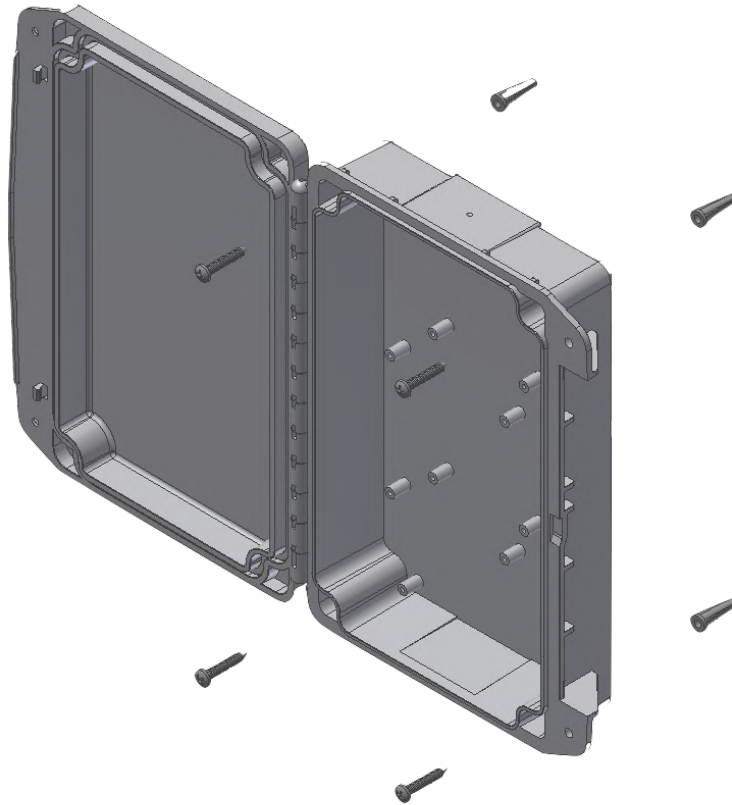

C. Connecting the Base Unit to the access controller

1. To connect the Base Unit to the access controller, 2 separate Wiegand ports must be available.
2. Connecting Board A to the access controller:
 - a. Wiegand Data: Connect Data 0, Data 1, and a common ground to the one Wiegand port on the access controller.
 - b. Access Granted Response: Connect an active low digital output to the LED In pin. Alternatively, a dry contact can be connected to the LED In pin and Ground. Make sure the output connected to the LED In pin is configured to activate for at least one second when a valid credential is received on this Wiegand port.
 - c. Access Denied Response: Connect an active low digital output to the Relay 1 In pin. Alternatively, a dry contact can be connected to the Relay 1 In pin and Ground. Make sure the output connected to the Relay 1 In pin is configured to activate for at least one second when an invalid credential is received on this Wiegand port.
 - d. Vend Feature: Connect Relay 3 COM and Relay 3 N.O. (normally open) to the access controller. This relay output can be used to control a door, a gate, or other equipment.
6. Connecting Board B to the access controller:
 - a. Wiegand Data: connect Data 0, Data 1, and a common ground to another Wiegand port on the access controller.
 - b. Access Granted Response: connect an active low digital output to the LED In pin. Alternatively, a dry contact can be connected to the LED In pin and Ground. Make sure the output connected to the LED In pin is configured to activate for at least one second when a valid credential is received on this Wiegand port.
 - c. Access Denied Response: Connect an active low digital output to the Relay 1 In pin. Alternatively, a dry contact can be connected to the Relay 1 In pin and Ground. Make sure the output connected to the Relay 1 In pin is configured to activate for at least one second when an invalid credential is received on this Wiegand port.
 - d. Vend Feature: connect Relay 3 COM and Relay 3 N.O. (normally open) to the access controller. This relay output can be used to control a door, a gate, or other equipment.
7. Board A and Board B need to be connected. Connect EXP(+) on Board A to EXP(+) on Board B. Connect EXP(-) on Board A to EXP(-) to Board B.
8. Use a power supply that can supply 8-16Vdc @ 600mA. Both Board A and Board B need to have a power connection, and each require 300 mA.

HHR-4X56B Dual-lane Kits - Field Installation (cont.)

D. Testing the Handheld Reader-to-Base Unit connection

The HHR readers should be changed before use in the field. The HHR-4256B and HHR-4356B kits have multiple readers, go through steps 1-8 for each reader.

1. Power on the reader. Press the IN lane selection button to set the reader to the IN lane. The blue LED will be on and solid when the reader is powered on. The blue LED will change to flashing when the reader is communicating with the Base Unit.
2. Present a valid credential to the reader. The red and green LEDs will flash once, indicating the credential has been read. Verify that the access controller has received the read on the Wiegand port Board A is connected to. Observe the Access Granted Response; the green LED will be flashing, the reader will vibrate, and the reader will emit a high pitched tone. The Access Granted Response will last as long as the LED In pin on Board A is activated.
3. Present an invalid credential to the reader. The red and green LEDs will flash once, indicating the credential has been read. Verify that the access controller has received the read on the Wiegand port Board A is connected to. Observe the Access Denied Response; the red LED will be flashing, the reader will vibrate in a pulsing pattern, and the reader will emit a low pitched tone. The Access Denied Response will last as long as the Relay 1 In pin on Board A is activated.
4. Press and release the Vend button. Verify that Relay 3 on Board A has changed state. Observe that the duress alarm activates, the door/gate opens, etc. A volt meter in continuity mode can also be used determine the state of the relay. When the Vend Button is pressed, there will be continuity between Relay 3 COM and Relay 3 N.O. for as long as the Vend Button is held down.
5. Press the OUT lane selection button to set the reader to the OUT lane. The blue LED should still be flashing, indicating the reader is communicating with the Base Unit.
6. Present a valid credential to the reader. The red and green LEDs will flash once, indicating the credential has been read. Verify that the access controller has received the read on the Wiegand port Board B is connected to. Observe the Access Granted Response; the green LED will be flashing, the reader will vibrate, and the reader will emit a high pitched tone. The Access Granted Response will last as long as the LED In pin on Board B is activated.
7. Present an invalid credential to the reader. The red and green LEDs will flash once, indicating the credential has been read. Verify that the access controller has received the read on the Wiegand port Board B is connected to. Observe the Access Denied Response; the red LED will be flashing, the reader will vibrate in a pulsing pattern, and the reader will emit a low pitched tone. The Access Denied Response will last as long as the Relay 1 In pin on Board B is activated.
8. Press and release the Vend button. Verify that Relay 3 on the Board B has changed state. Observe that the duress alarm activates, the door, gate, or other equipment. A volt meter in continuity mode can also be used determine the state of the relay. When the Vend Button is pressed, there will be continuity between Relay 3 COM and Relay 3 N.O. for as long as the Vend Button is held down.

HHR-4X56B Dual-lane Kits - Battery Life, Charging, and Protective Boot (cont.)

Charging

The HHR-8056B can be used for 8 hours before needing to be charged. The HHR-8056B requires 4 hours to be fully charged.

To charge the HHR-8056B reader, set up the HHR-RCHL charger and HHR-DOCK charging dock. Plug the HHR-RCHL into a wall outlet and then plug the HHR-RCHL's barrel plug into the back of the HHR-DOCK. Now the HHR-8066B can be charged by removing the reader from its boot and placing it into the HHR-DOCK.

The HHR-8056B reader uses a Lithium Polymer battery, it is important that the HHR-8056B is charged only with the HHR-RCHL, see warning on page 6.

The HHR-RCHL has an LED indicator. This LED will either display red or green (shown in the pictures below).

The LED is red when the HHR-8056B is being charged. The LED is green when the HHR-8056B is charged or not charging. If the HHR-8056B is in the HHR-DOCK, then the reader is charged. The LED also displays green when the HHR-RCHL is plugged into a wall outlet and the HHR-8056B is not in the HHR-DOCK.



The LED is red; the reader in the HHR-DOCK is charging.



The LED is green; the reader is either charged or not in the HHR-DOCK.

HHR-4X56B Dual-lane Kits - Battery Life, Charging, and Protective Boot (cont.)

Removing the BOOT for charging

The HHR reader must be removed from the boot in order to be placed in the charging dock.

To remove the boot from the HHR reader, push the top corners of the boot up and over the top corners of the reader, then pull the exposed reader out of the boot.

To put the HHR reader back in the boot, place the bottom of the HHR reader in the bottom of the boot. Then pull the top of the boot up and over the top of the reader until it is secure.

About the Protective Boot

The HHR-BOOT is included with each HHR reader in the HHR-4000B kits. The boot provides protection for compatible HHR readers and allows the user to easily carry the reader using the shoulder strap.

The shoulder strap is connected to the HHR-BOOT with two clips connected to the D-rings on the bottom of the boot. The breakaway shoulder strap can be removed if necessary.



The two pictures below show the charging contacts on the HHR-DOCK and HHR-8056B. The HHR-8056B sits in the HHR-DOCK and the charging contacts connect.



HHR-4X56B Dual-lane Kits - Battery Life, Charging, and Protective Boot (cont.)

The pictures below show the charging port on the HHR-DOCK that the barrel plug on the HHR-RCHL charger plugs into.

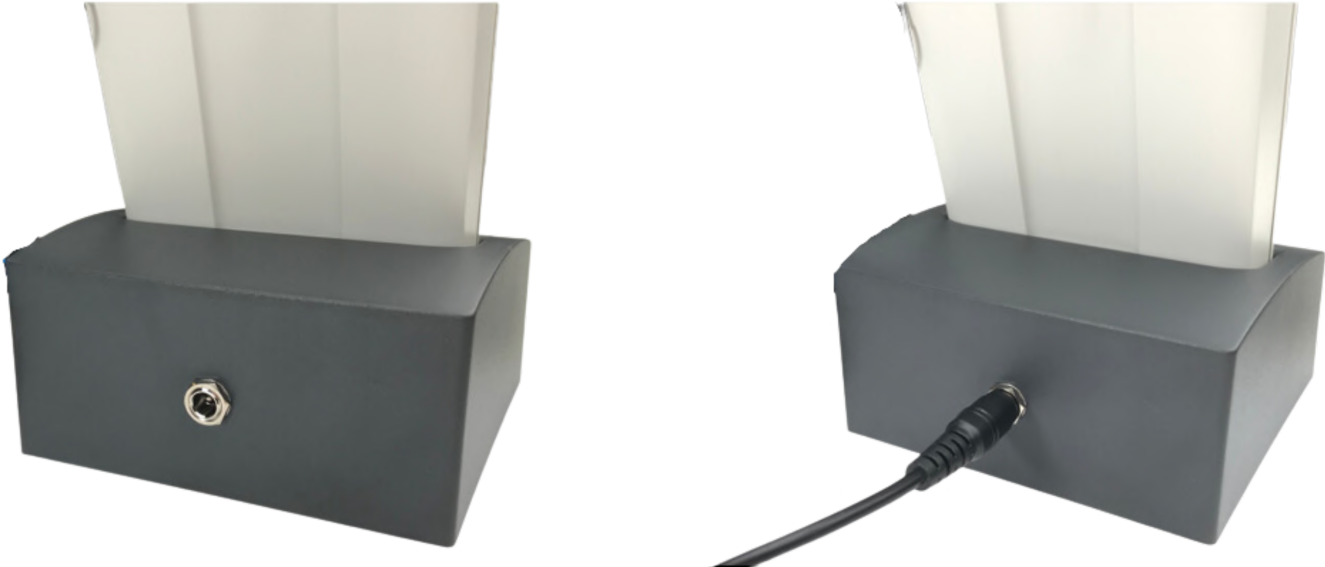

The picture below shows the complete charging set up. The HHR-RCHL charger is plugged into an outlet and connected to the HHR-DOCK; and the HHR-8056B set into the HHR-DOCK.



HHR-4X56B Dual-lane Kits - Troubleshooting

Reader to Base Communication Troubleshooting:

The Blue LED on the HHR-8056B reader shows the communication status between the HHR-8056B reader and the HHR-8400 Base Unit. When the Blue LED is solid, the reader is not communicating with the base unit. When the Blue LED is flashing, the reader is communicating with the Base Unit.

- Make sure the reader is powered on and in range of the Base Unit. Move closer to the Base Unit, until the reader is able to communicate with the Base Unit.
- Make sure the Base Unit is powered on and Board A and Board B are connected together. EXP(+) on Board A needs to be connected to EXP(+) on Board B, and EXP(-) on Board A needs to be connected to EXP(-) on Board B.
- Present a valid credential to the reader while set to the IN Lane. Check the access controller log to verify that the credential was received on the correct port.
- Present a valid credential to the reader while set to the OUT Lane. Check the access controller log to verify that the credential was received on the correct port.

The reader to base communication can also be tested with the Vend feature. When the Vend button is pressed, Relay 3 will activate on either Board A or Board B.

- Set the reader to the IN Lane. Press and hold the Vend button. Observe that Relay 3 on Board A has changed state.
- Set the reader to the OUT Lane. Press and hold the Vend button. Observe that Relay 3 on Board B has changed state.

Wiegand Communication Troubleshooting:

Both Board A and Board B need to have proper Wiegand connections to the access controller.

- Make sure Board A and Board B have a common ground connection with the access controller.
- Make sure the D0 and D1 pins on Board A are connected to D0 and D1 on the access controller Wiegand port, and are not reversed.
- Make sure the D0 and D1 pins on Board B are connected to D0 and D1 on the access controller Wiegand port, and are not reversed.

If the access controller is not receiving the credential data, the next step is to check the Wiegand data voltage. The voltage on the D0 and D1 lines should idle at 5V, relative to ground, on both Board A and Board B.

- Use a volt meter to measure the DC voltage between D0 and ground, and D1 and ground on Board A.
- Use a volt meter to measure the DC voltage between D0 and ground, and D1 and ground on Board B

If one or more of the data lines is below 4.5V, this could be the cause of the communication failure.

- Disconnect the low data line from the Base Unit and the access controller.
- Measure DC voltage between the low data line and ground on the Base Unit.
- Measure DC voltage between the low data line and ground on the access controller.

Typically, one of the devices is causing the problem and will be low, while the other is normal at 5V. If the voltage on the low data line is between 1V and 4.4V, it can usually be recovered by installing an external pull-up resistor. If the voltage on the low data line is below 1V, it is likely grounded, and cannot be recovered with external pull-up resistors.

HHR-4X56B Dual-lane Kits - Troubleshooting (cont.)

Access Granted Response

The Access Granted Response is controlled by the LED In pin. The LED In pin is a digital I/O pin that is normal at 5V and active at 0V. The Access Granted Response can only be activated within 5 seconds of a credential being presented to the reader.

- Make sure the LED In pin on Board A is connected to an output on the access controller.
- Make sure the LED In pin on Board B is connected to an output on the access controller.
- Make sure the access controller is configured to activate the output for Board A and Board B when a valid credential is received.

If the connection to the access controllers is in place and working correctly, the next step is to check is the idle voltage of the LED In pin. The LED In pin idles at 5V, if the voltage is below 4.4V then that is likely the cause of the problem.

- Measure the DC voltage between LED In and ground on Board A.
- Measure the DC voltage between LED In and ground on Board B.

If the voltage on the LED In pin is between 1V and 4.4V, then an external pull-up resistor can be used to recover the pin. If the voltage on the LED In pin is lower than 1V, then it cannot be recovered.

The troubleshooting steps are the same for the Access Granted Response and Access Denied Response, except that the Access Denied Response is controlled by the Relay 1 In pins on Board A and Board B.

HHR-4X56B Dual-lane Kits - Installing External Pull-up Resistors

External pull-up resistors are used to pull up the voltage of damaged digital I/O pins to 5V, if the pin has been damaged and is between 1.0V and 4.4V. Through-hole resistors with values between 1k and 2.7k Ohms can be used. The higher the resistor value, the stronger the pull-up effect. For instance, using a lower value pull-up resistor may not pull the voltage all the way up to 5V. In these cases, a stronger pull-up resistor needs to be used. One end of the pull-up resistor is connected to the +5V Out pin; the other is connected to the low digital I/O pin (see diagram, below).

Board A

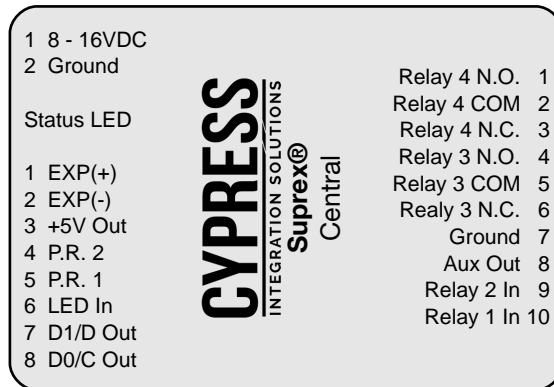

Board B

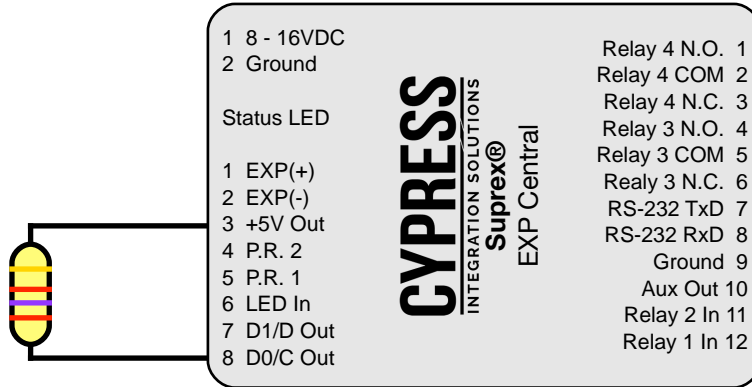

This example shows a 2.7k Ohm pull-up resistor being installed on the Board B D0 Wiegand data line. If necessary, multiple external pull-up resistors can be installed if multiple Wiegand data lines are low.